

HONGISTO OY:n 25tm linkkunosturi

Nostokaaviot.

Annetuista arvoista poiketen 2000kg nostoetäisyys on 12,5m Suomen lainsäädännön takia

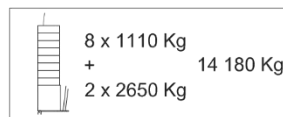
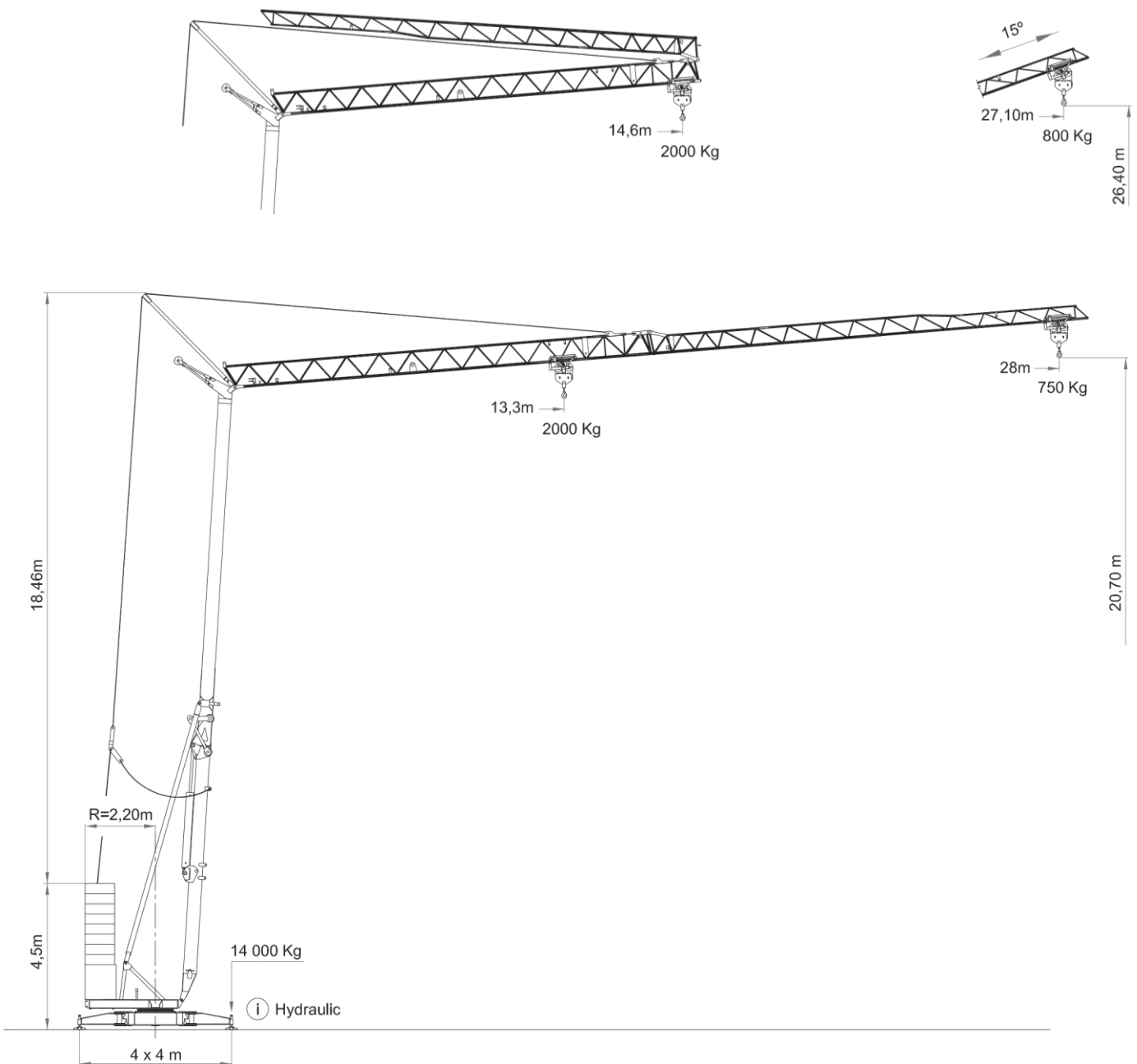

DIN/FEM 
EN 14439-FEM 1005- C25



HONGISTO OY:n 25tm linkkunosturi

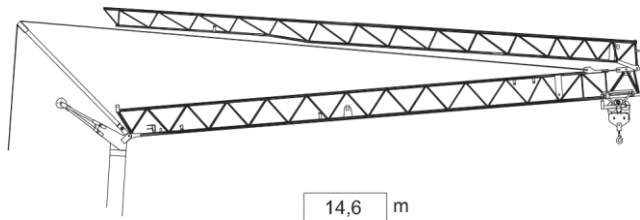

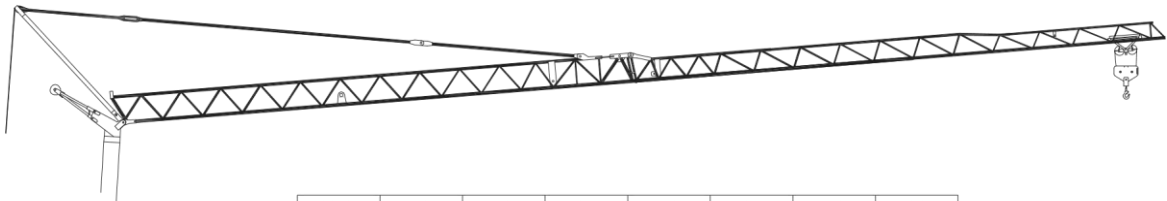

14,6	m
2000	Kg

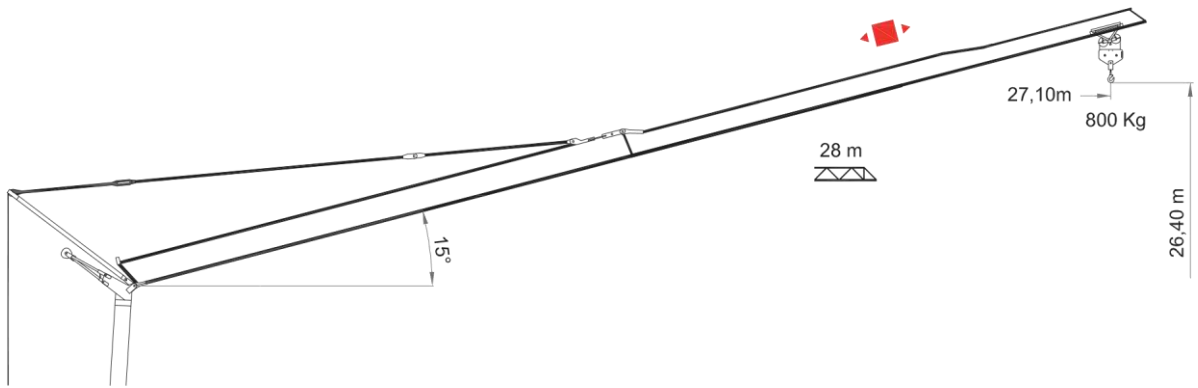

28 m	13,3	16	18	20	22	24	26	28	m
	2000	1566	1341	1168	1031	920	827	750	Kg

Nostettu jib-puomi











28 m	0	27,10	m
		800	Kg



HONGISTO OY:n 25tm linkkunosturi

Tekniset tiedot



10Hp (7,5Kw) INV
HBG 20,7m S/R Ø10mm
7,5Hp (5,5Kw) INV

		m/min	5	20,5	40
		Kg	2000	2000	1000
		Kw	7,5		
		m/min	19	45	
		Kw	2,2		
		r.p.m.	0,25	0,5	0,8
		N.m.	30		
		Kw	4		

10Hp (7,5Kw) - INV

 2000/14/CEE 2005/88/CEE	 2006/95/CEE	400V 50Hz I _{max} .= 24A Fuse= 25A	TOTAL POWER 14 KVA	GENERATOR 25 KVA	100m 4x6mm ²	150m 4x10mm ²	200m 4x10mm ²
---	--	---	-----------------------	---------------------	----------------------------	-----------------------------	-----------------------------

10Hp (7,5Kw) - INV

 2000/14/CEE 2005/88/CEE	 2006/95/CEE	230V 50Hz I _{max} .= 32A Fuse= 32A	TOTAL POWER 7,4 KVA	GENERATOR 14 KVA	100m 5x6mm ²	150m 5x6mm ²	200m 5x6mm ²
---	--	---	------------------------	---------------------	----------------------------	----------------------------	----------------------------

Nosturin kasauskaavio

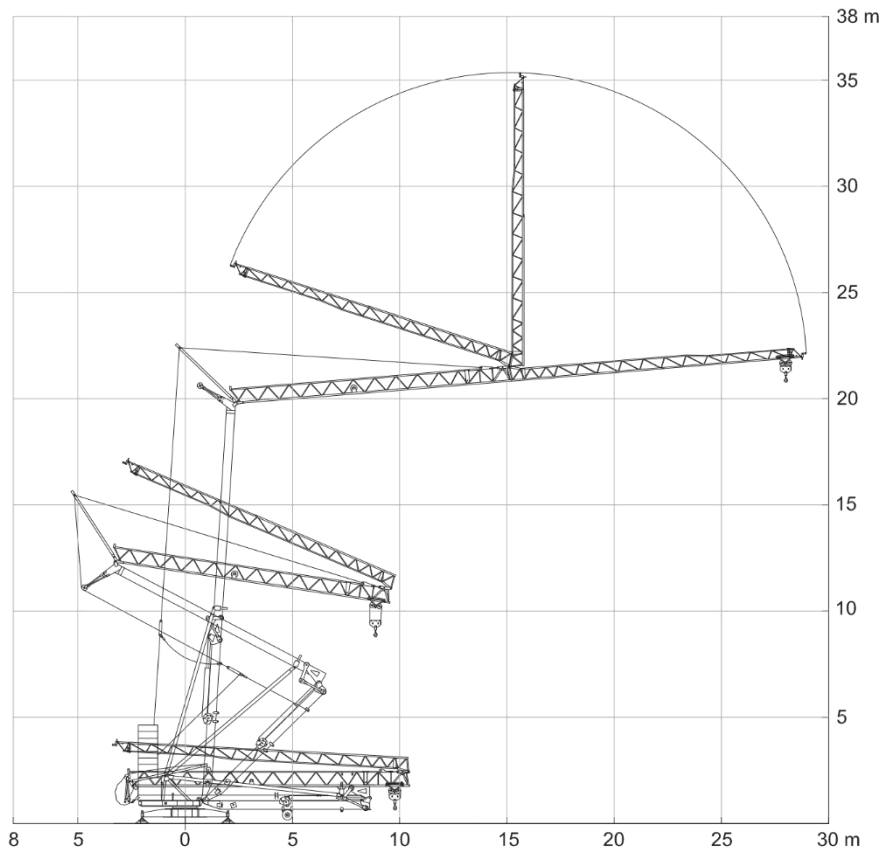

HONGISTO OY:n 25tm linkkunosturi

Kuljetusmitat – toimitetaan Hongiston hiab-autolla ja peräkärryllä

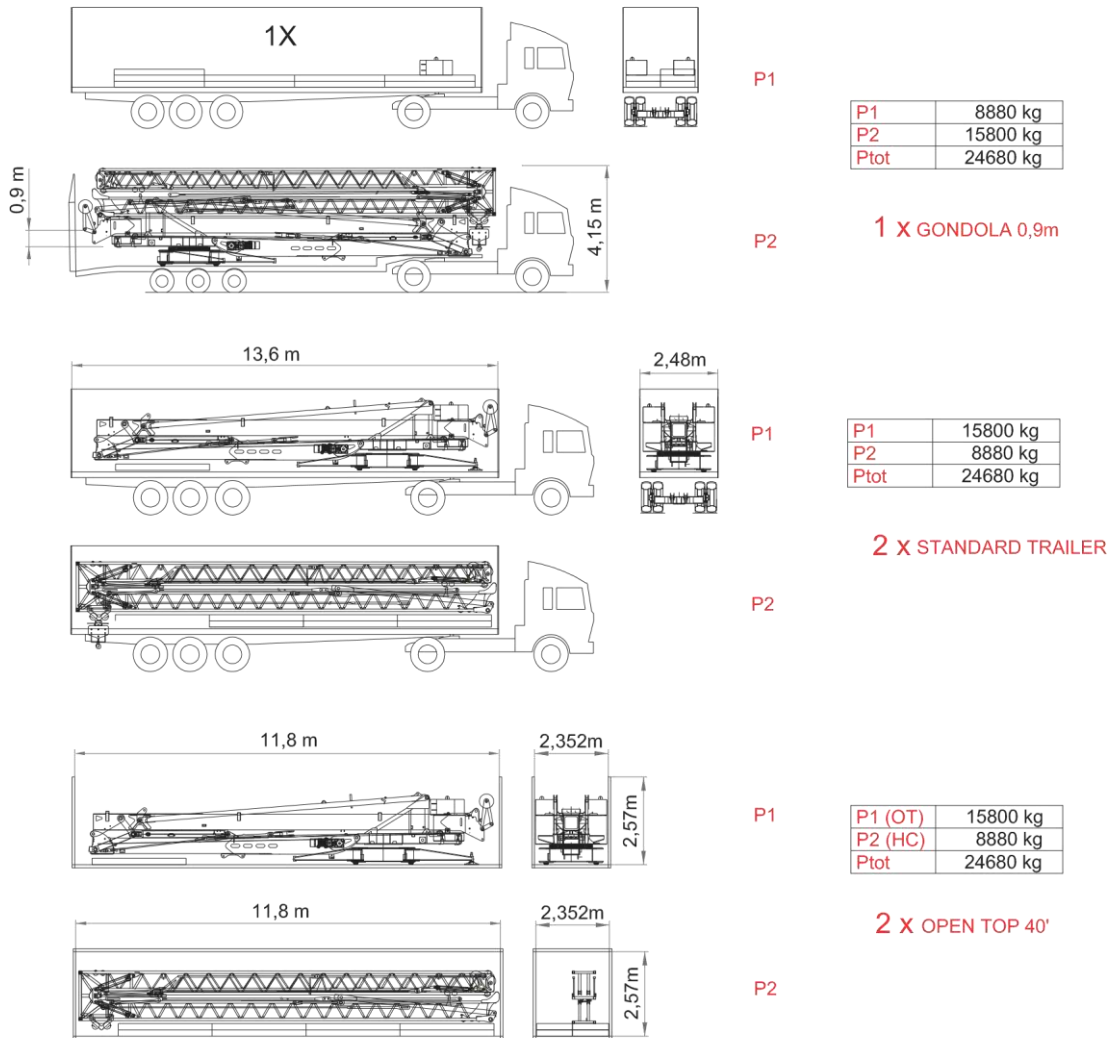

(i) Consultarnos - Consultateci - Consult us - Nous consulter - Auf anfrage - советоваться

HONGISTO OY:n 25tm linkkunosturi

